

EBB & FLOW

Technical information

IP44 Kit

Horizon Ceiling/Wall

Ø21, Ø29 & Ø36

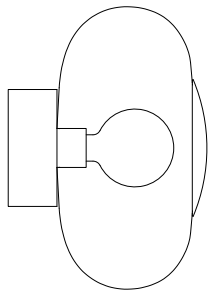

Content: 3 rubber fittings

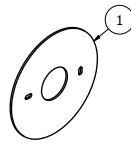

1. Surface disk

Fit to surface as shown below

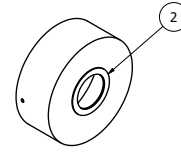

2. Collar

2 & 3 prefitted by EBB & FLOW

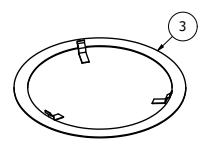

3. Ring

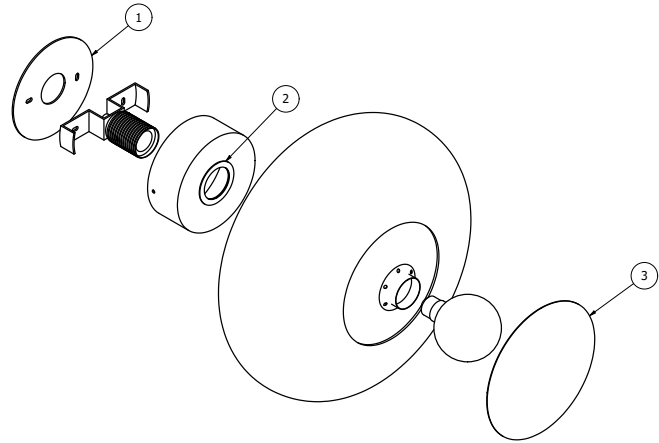

EBB & FLOW

Technical information

IP44 Kit

Horizon Ceiling/Wall

Ø21, Ø29 & Ø36

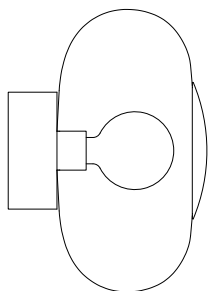

Content: 3 rubber fittings

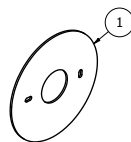

1. Surface disk

Fit to surface as shown below

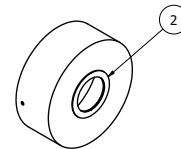

2. Collar

2 & 3 prefitted by EBB & FLOW

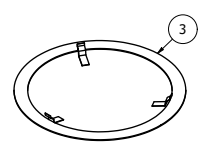

3. Ring

