

ASSEMBLY INSTRUCTIONS

TABLE CLASS 180X90

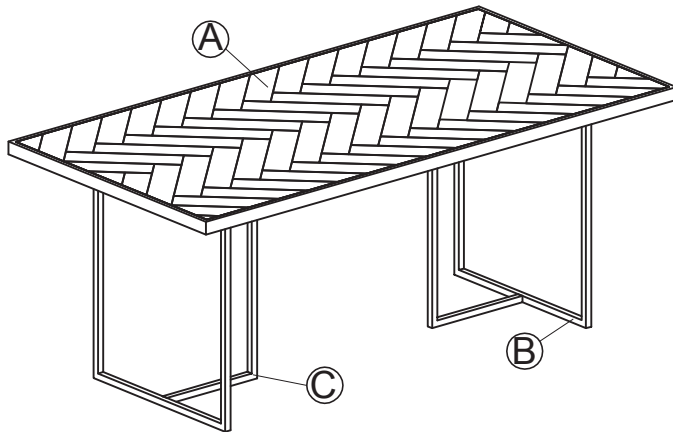

Parts Check List

Code	Components	Qty
(A)	TABLE TOP	x1
(B)	PART 1	x2
(C)	PART 2	

Fittings Check List

Code	Components	Qty
01	Allen long bolt	x10
02	Allen short bolt	x4
03	Spring washer	x12
04	Flat washer	x14
05	Allen key	x1

- Please do not discard any of the packaging until you have checked all the parts and the hardware packages.
- Before you begin to assemble your new piece of furniture, please check to ensure that all parts have been supplied.
- Follow instructions closely as deviation from them may void your warranty and present a possible safety risk.
- It is recommended that assembly is done on a soft surface like carpet to avoid any damage.
- Periodically check and re-tighten any fasteners. wipe down all surfaces weekly with a clean cloth. do not clean any surfaces with harsh abrasives or chemicals.

1.

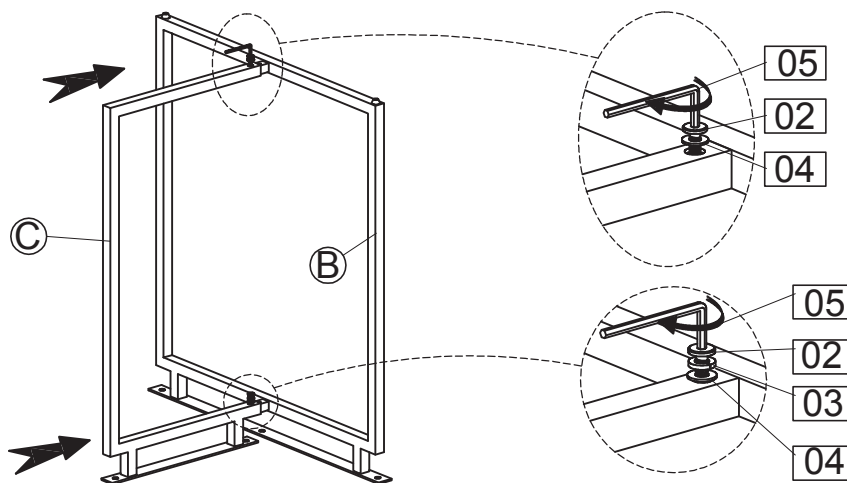

2.

