

ZUIVER^o

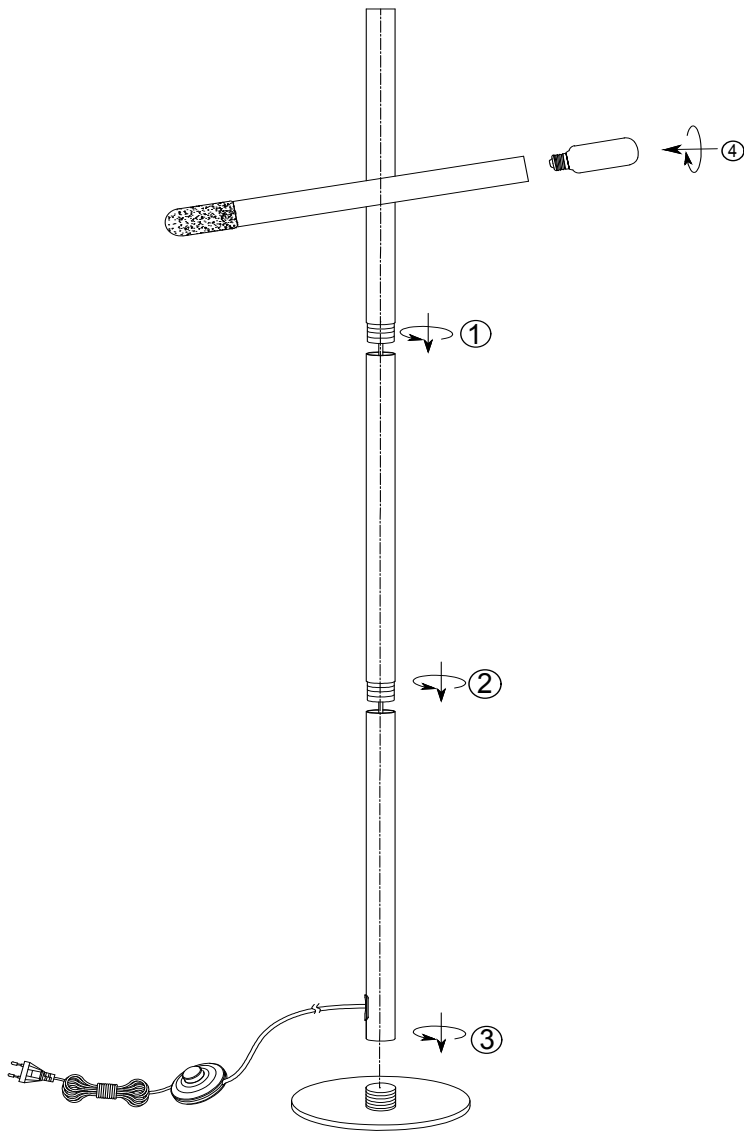

Assembly Instruction

1. Before assembling, be sure to turn off the main switch.
2. Don't use hard or sharp things to touch the frame in order to avoid scratching.
3. Keep away from children: don't let them touch the electric parts of this lamp.

If (part of) the cable of this lamp is damaged, it should only be replaced by the manufacturer or his service agent or similar qualified person in order to avoid a hazard.

Item Number: 5100099