

Outdoor bird feeder Installation Guide

Outdoor bird feeder Installation Guide

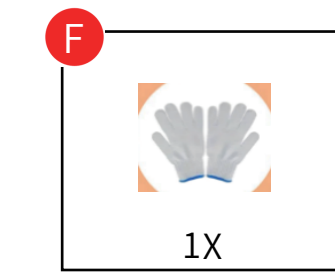
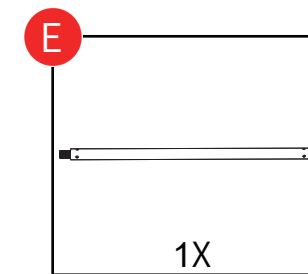
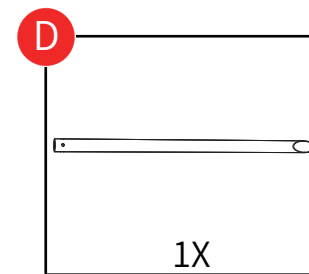
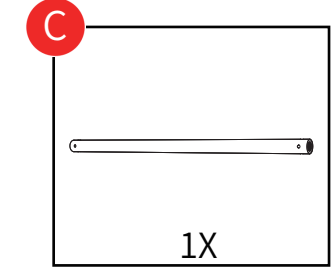
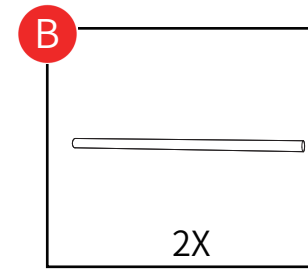
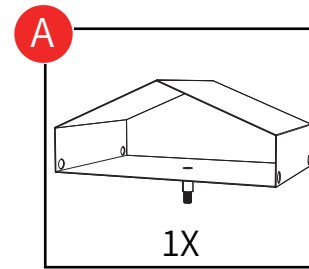
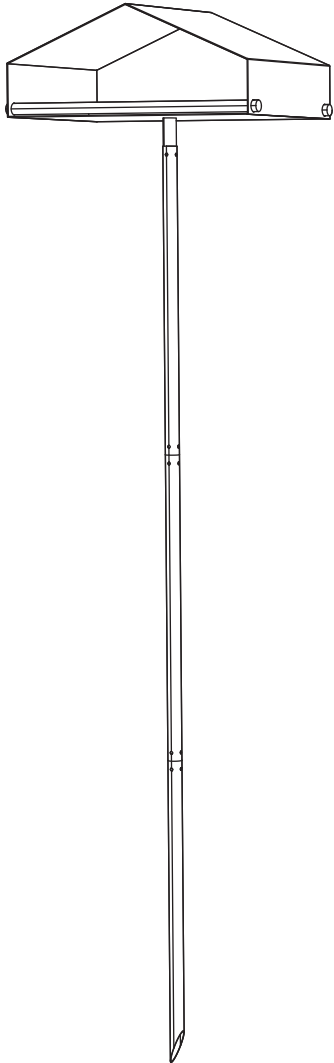

Outdoor bird feeder Installation Guide

1. As shown in the figure, combine component B rod and component A together by inserting them into each other.

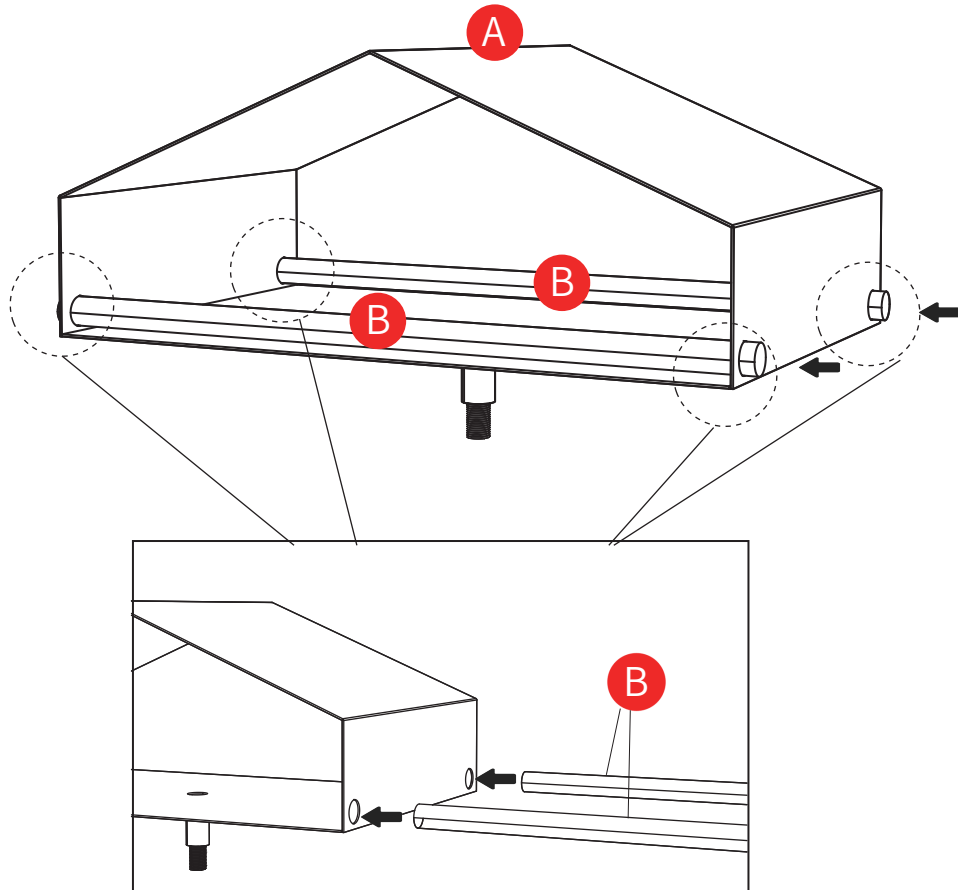

Outdoor bird feeder Installation Guide

2. As shown in the figure, screw the C tube together with the E tube, and screw the E tube together with the D tube.

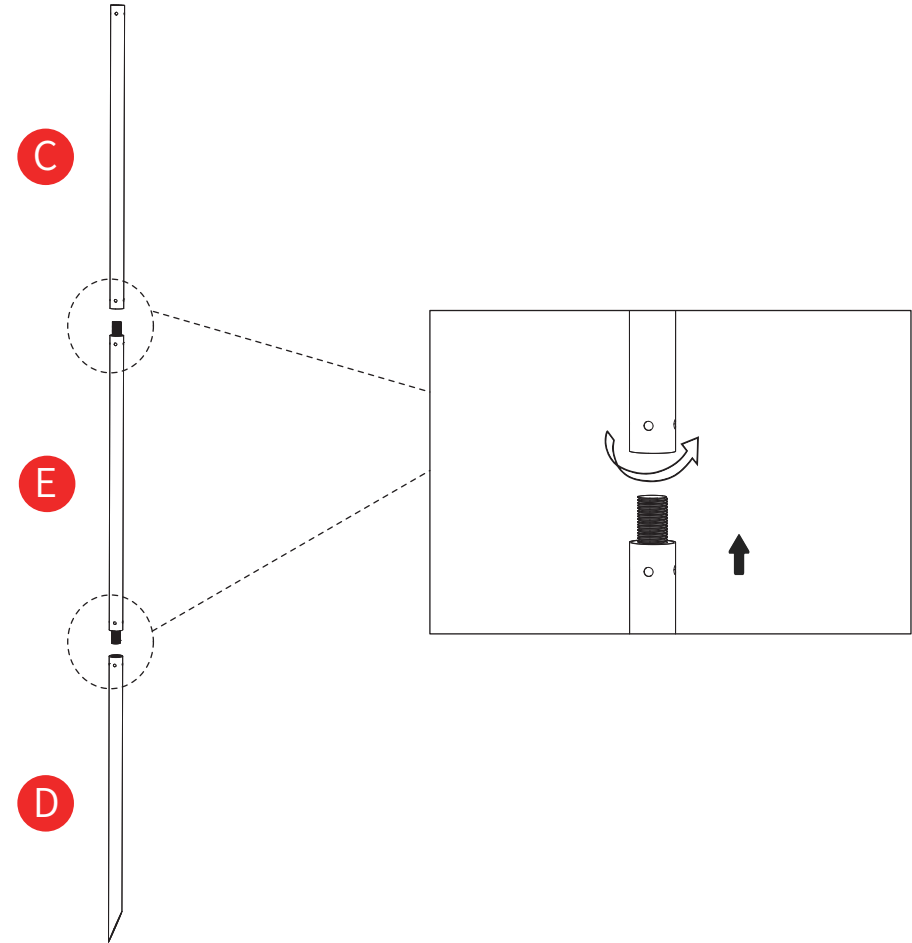

Outdoor bird feeder Installation Guide

Outdoor bird feeder Installation Guide

3. As shown in the figure, attach component A to the combination tubes C, E, and D together.

